

Article number: 2301072662
Description: E+G Handwheel
VDS.100-A12

Measures

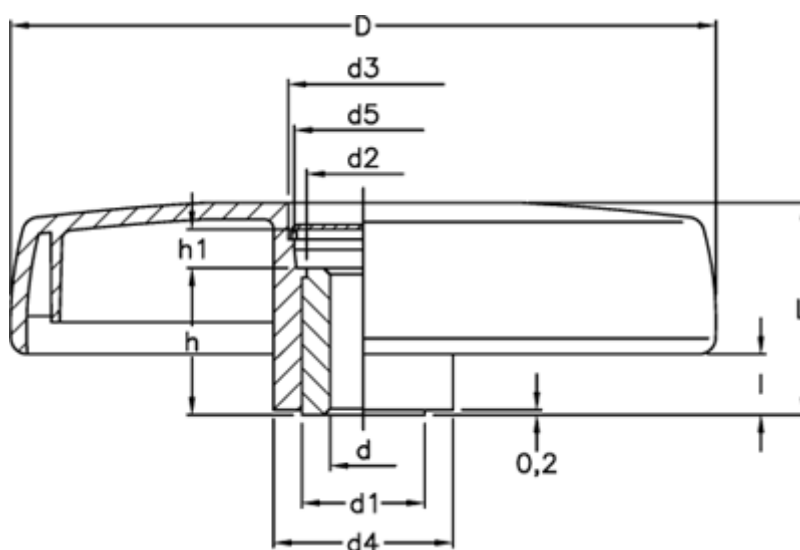

C (N m) = 60	h = 22
D = 102	h1 = 9
d1 = 22	l = 10
d2 = 20	L = 34
d3 = 27	L (J) = 13
d4 = 30	
d5 = 25	
d H7 = 12	